

Dell|EMC AX4-5i iSCSI Storage Arrays
With Microsoft[®] Windows Server[®]
Failover Clusters

Hardware Installation and Troubleshooting Guide

Notes, Notices, and Cautions



NOTE: A NOTE indicates important information that helps you make better use of your computer.



NOTICE: A NOTICE indicates either potential damage to hardware or loss of data and tells you how to avoid the problem.



CAUTION: A CAUTION indicates a potential for property damage, personal injury, or death.

Information in this document is subject to change without notice.

© 2008 Dell Inc. All rights reserved.

Reproduction in any manner whatsoever without the written permission of Dell Inc. is strictly forbidden.

Trademarks used in this text: *Dell*, the *DELL* logo, *PowerEdge*, *PowerVault*, and *OpenManage* are trademarks of Dell Inc.; *Active Directory*, *Microsoft*, *Windows*, *Windows Server*, and *Windows NT* are either trademarks or registered trademarks of Microsoft Corporation in the United States and/or other countries; *EMC*, *Navisphere*, and *PowerPath* are registered trademarks and *MirrorView*, *SAN Copy*, and *SnapView* are trademarks of EMC Corporation.

Other trademarks and trade names may be used in this document to refer to either the entities claiming the marks and names or their products. Dell Inc. disclaims any proprietary interest in trademarks and trade names other than its own.

Contents

1	Introduction	5
	Cluster Solution	6
	Cluster Hardware Requirements	6
	Cluster Nodes.	7
	Cluster Storage	8
	NICs Dedicated to iSCSI	9
	Ethernet Switches Dedicated to iSCSI	9
	Supported Cluster Configurations	9
	Direct-Attached Cluster	9
	iSCSI SAN-Attached Cluster	10
	Other Documents You May Need	11
2	Cabling Your Cluster Hardware	13
	Cabling the Mouse, Keyboard, and Monitor	13
	Cabling the Power Supplies	13
	Cabling Your Cluster for Public and Private Networks	15
	Cabling the Public Network	16
	Cabling the Private Network	17
	NIC Teaming	17
	Cabling the Storage Systems	18
	Cabling Storage for Your Direct-Attached Cluster	18
	Cabling Storage for Your iSCSI SAN-Attached Cluster	20

3	Preparing Your Systems for Clustering	27
	Cluster Configuration Overview	27
	Installation Overview	29
	Installing the iSCSI NICs	30
	Installing the Microsoft iSCSI Software Initiator	30
	Modifying the TCP Registry Settings	31
	Installing EMC® PowerPath®	31
	Configuring the Shared Storage System	32
	Installing and Configuring a Failover Cluster	41
A	Troubleshooting	43
B	Cluster Data Form	49
C	iSCSI Configuration Worksheet	51
	Index	53

Introduction

A Dell™ Failover Cluster combines specific hardware and software components to provide enhanced availability for applications and services that run on your cluster. A Failover Cluster reduces the possibility of any single point of failure within the system that can cause the clustered applications or services to become unavailable. It is recommended that you use redundant components like servers, storage power supplies, connections between the nodes and the storage array(s), connections to client systems or other servers in a multi-tier enterprise application architecture in your cluster.

This document provides information and specific configuration tasks that enable you to configure your Failover Cluster with Dell|EMC AX4-5i Internet Small Computer System Interface (iSCSI) storage array(s).

For more information on deploying your cluster with Windows Server 2003 operating systems, see the *Dell™ Failover Clusters with Microsoft Windows Server 2003 Installation and Troubleshooting Guide* located on the Dell Support website at support.dell.com. For more information on deploying your cluster with Windows Server 2008 operating systems, see the *Dell Failover Clusters with Microsoft Windows Server 2008 Installation and Troubleshooting Guide* located on the Dell Support website at support.dell.com.

For a list of recommended operating systems, hardware components, and driver or firmware versions for your Failover Cluster, see the *Dell Cluster Configuration Support Matrices* located on the Dell High Availability Clustering website at www.dell.com/ha.

Cluster Solution

Your cluster supports a minimum of two nodes to a maximum of either eight nodes (with Windows Server 2003 operating systems) or sixteen nodes (with Windows Server 2008 operating systems) and provides the following features:

- Gigabit Ethernet technology for iSCSI clusters
- High availability of resources to network clients
- Redundant paths to the shared storage
- Failure recovery for applications and services
- Flexible maintenance capabilities, allowing you to repair, maintain, or upgrade a node or storage system without taking the entire cluster offline

The iSCSI protocol encapsulates SCSI frames that include commands, data, status and so on to Transmission Control Protocol/Internet Protocol (TCP/IP) packets to be transported over Ethernet networks. The iSCSI data blocks are sent between the Microsoft iSCSI Initiator that resides in the host and the iSCSI target, which is usually a storage device. Implementing iSCSI in a cluster provides the following advantages:

- Geographic distribution — Wider coverage of Ethernet technology allows cluster nodes and storage systems to be located in different sites.
- Low cost for Availability — Redundant connections provide multiple data paths that are available through inexpensive TCP/IP network components.
- Connectivity — A single technology for connection of storage systems, cluster nodes and clients within existent local area network (LAN), wide area network (WAN), and storage network.

Cluster Hardware Requirements

Your cluster requires the following hardware components:

- Cluster nodes
- Cluster storage

Cluster Nodes

Table 1-1 lists the hardware requirements for the cluster nodes.

Table 1-1. Cluster Node Requirements

Component	Minimum Requirement
Cluster nodes	A minimum of two identical PowerEdge servers are required. The maximum number of nodes that is supported depends on the variant of the Windows Server operating system used in your cluster, and on the physical topology in which the storage system and nodes are interconnected.
RAM	The variant of the Windows Server operating system that is installed on your cluster nodes determines the minimum required amount of system RAM.
iSCSI Initiator	Install the iSCSI port driver, Initiator Service, and Software Initiator on each node.
Network Interface Cards (NICs) for iSCSI access	Two iSCSI NICs or two iSCSI NIC ports per node. Configure the NICs on separate PCI buses to improve availability and performance. TCP/IP Offload Engine (TOE) NICs are also supported for iSCSI traffic.
NICs (public and private networks)	At least two NICs: one NIC for the public network and another NIC for the private network. NOTE: It is recommended that the NICs on each public network are identical, and that the NICs on each private network are identical.
Internal disk controller	One controller connected to at least two internal hard drives for each node. Use any supported RAID controller or disk controller. Two hard drives are required for mirroring (RAID 1) and at least three are required for disk striping with parity (RAID 5). NOTE: It is strongly recommended that you use hardware-based RAID or software-based disk-fault tolerance for the internal drives.

Cluster Storage

Cluster nodes can share access to external storage systems. However, only one of the nodes can own any RAID volume in the external storage system at any time. Microsoft Cluster Services (MSCS) controls which node has access to each RAID volume in the shared storage system.

Table 1-2 lists the supported storage systems and the configuration requirements for the cluster nodes and stand-alone systems connected to the storage systems.

Table 1-2. Cluster Storage Requirements

Hardware Components	Requirement
Supported storage systems	One to four supported Dell EMC storage systems. For specific storage system requirements, see Table 1-3.
Cluster nodes	All nodes must be directly attached to a single storage system or attached to one or more storage systems through a SAN.
Multiple clusters and stand-alone systems	Can share one or more supported storage systems.

The storage systems work together with the following hardware components:

- Disk Processor Enclosure (DPE)—Configured with storage processors that control the RAID arrays in the storage system and provide storage functionalities such as snapshots, LUN masking, and remote mirroring.
- Disk Array Enclosure (DAE)—Provides additional storage and is attached to the disk processor enclosure.
- Standby Power Supply (SPS)—Provides backup power to protect the integrity of the disk processor write cache. The SPS is connected to the disk processor enclosure.

Table 1-3 lists hardware requirements for the AX4-5i storage array.

Table 1-3. Dell|EMC Storage System Requirements

Processor Enclosure	Minimum Required Storage	Possible Storage Expansion	SPS
AX4-5i	One DPE with at least 4 and up to 12 hard drives	Up to three DAE with a maximum of 12 hard drives each	1 (required) and 2 (optional)



NOTE: Ensure that the core software version running on the storage system is supported. For specific version requirements, see the *Dell Cluster Configuration Support Matrices* located on the Dell High Availability Cluster website at www.dell.com/ha.

NICs Dedicated to iSCSI

The NIC controlled by iSCSI Software Initiator acts as an I/O adapter to connect the system's expansion bus and the storage components. Failover Cluster solutions that are configured with the AX4-5i storage array require two iSCSI NICs or NIC ports in each PowerEdge system to provide redundant paths and load balance the I/O data transfer to the storage system.

Ethernet Switches Dedicated to iSCSI

The Gigabit switch for iSCSI access functions as a regular network switch that provides extension and dedicated interconnection between the node and the storage system(s).

Supported Cluster Configurations

Direct-Attached Cluster

In a direct-attached cluster, both nodes of the cluster are directly attached to a single storage system. In this configuration, the RAID controllers (or storage processors) on the storage systems are connected by cables directly to the iSCSI NIC ports in the nodes.

Figure 1-1 shows a basic direct-attached, single-cluster configuration.

Figure 1-1. Direct-Attached, Single-Cluster Configuration

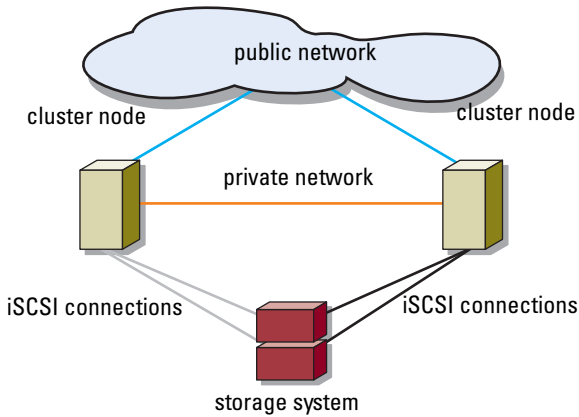

EMC PowerPath Limitations in a Direct-Attached Cluster

EMC PowerPath provides failover capabilities and multiple path detection as well as dynamic load balancing between multiple ports on the same storage processor. However, direct-attached clusters supported by Dell connect to a single port on each storage processor in the storage system. Because of the single port limitation, PowerPath can provide only failover protection, not load balancing, in a direct-attached configuration.

iSCSI SAN-Attached Cluster

In an iSCSI switch-attached cluster, all of the nodes are attached to a single storage system or to multiple storage systems through redundant LANs for high-availability. iSCSI SAN-attached clusters are superior to direct-attached clusters in configuration flexibility, expandability, and performance.

Figure 1-2 shows an iSCSI SAN-attached cluster.

Figure 1-2. iSCSI SAN-Attached Cluster

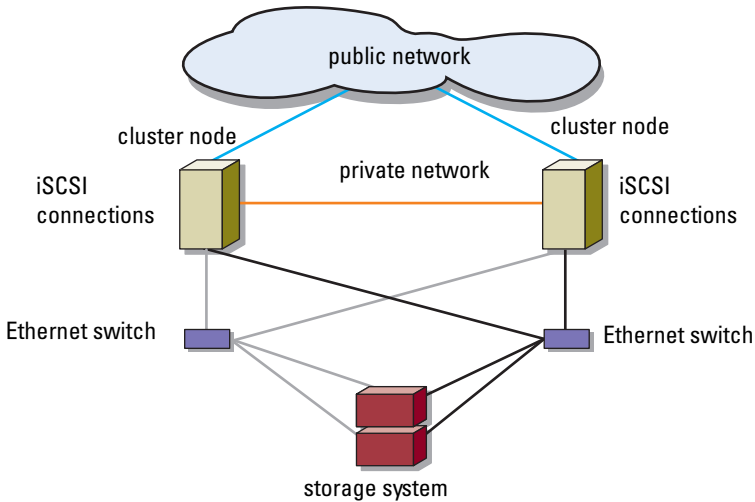

Other Documents You May Need

⚠ CAUTION: For important safety and regulatory information, see the safety information that shipped with your system. Warranty information may be included within this document or as a separate document.

📎 NOTE: To configure Dell blade server modules in a Dell PowerEdge cluster, see the *Using Dell Blade Servers in a Dell PowerEdge High Availability Cluster* document located on the Dell Support website at support.dell.com.

📎 NOTE: All documentation in the list below, unless indicated otherwise, is available on the Dell Support website at support.dell.com.

- The *Rack Installation Guide* included with your rack solution describes how to install your system into a rack.
- The *Getting Started Guide* provides an overview of initially setting up your system.
- The *Dell Failover Clusters with Microsoft Windows Server 2003 Installation and Troubleshooting Guide* provides more information on deploying your cluster with the Windows Server 2003 operating system.

- The *Dell Failover Clusters with Microsoft Windows Server 2008 Installation and Troubleshooting Guide* provides more information on deploying your cluster with the Windows Server 2008 operating system.
- The *Dell Cluster Configuration Support Matrices* provides a list of recommended operating systems, hardware components, and driver or firmware versions for your Failover Cluster.
- Operating system documentation describes how to install (if necessary), configure, and use the operating system software.
- Documentation for any hardware and software components you purchased separately provides information to configure and install those options.
- The Dell PowerVault™ tape library documentation provides information for installing, troubleshooting, and upgrading the tape library.
- The EMC PowerPath documentation and Dell|EMC Storage Enclosure User's Guides.



NOTE: Always read the updates first because they often supersede information in other documents.

- Release notes or readme files may be included to provide last-minute updates to the system or documentation, or advanced technical reference material intended for experienced users or technicians.

Cabling Your Cluster Hardware



NOTE: To configure Dell blade server modules in a Dell™ PowerEdge™ cluster, see the *Using Dell Blade Servers in a Dell PowerEdge High Availability Cluster* document located on the Dell Support website at support.dell.com.

Cabling the Mouse, Keyboard, and Monitor

When installing a cluster configuration in a rack, you must include a switch box to connect the mouse, keyboard, and monitor to the nodes. For instructions on cabling each node's connections to the switch box, see the documentation included with your rack.

Cabling the Power Supplies

Refer to the documentation for each component in your cluster solution to ensure that the specific power requirements are satisfied.

The following guidelines are recommended to protect your cluster solution from power-related failures:

- For nodes with multiple power supplies, plug each power supply into a separate AC circuit.
- Use uninterruptible power supplies (UPS).
- For some environments, consider having backup generators and power from separate electrical substations.

Figure 2-1, and Figure 2-2 illustrate recommended methods for power cabling for a cluster solution consisting of two PowerEdge systems and two storage systems. To ensure redundancy, the primary power supplies of all the components are grouped onto one or two circuits and the redundant power supplies are grouped onto a different circuit.

Figure 2-1. Power Cabling Example With One Power Supply in the PowerEdge Systems and One SPS in the AX4-5i Storage Array

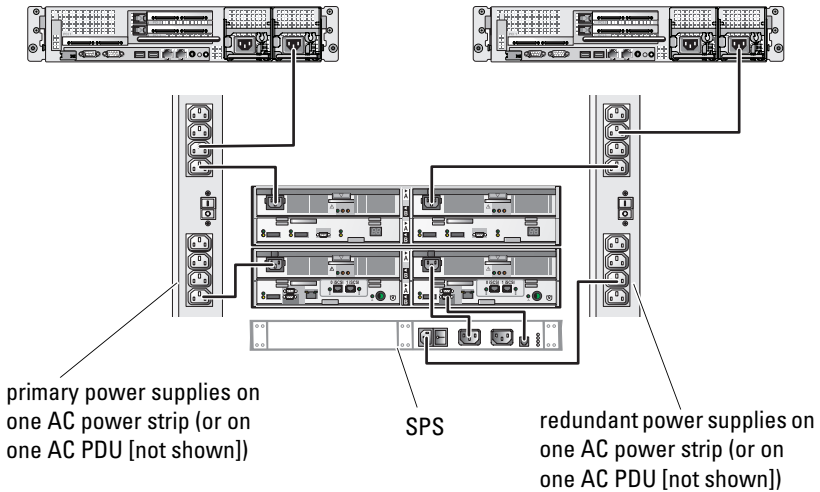

 **NOTE:** This illustration is intended only to demonstrate the power distribution of the components.

Figure 2-2. Power Cabling Example With Two Power Supplies in the PowerEdge Systems and Two SPSs in the AX4-5i Storage Array



NOTE: This illustration is intended only to demonstrate the power distribution of the components.

Cabling Your Cluster for Public and Private Networks

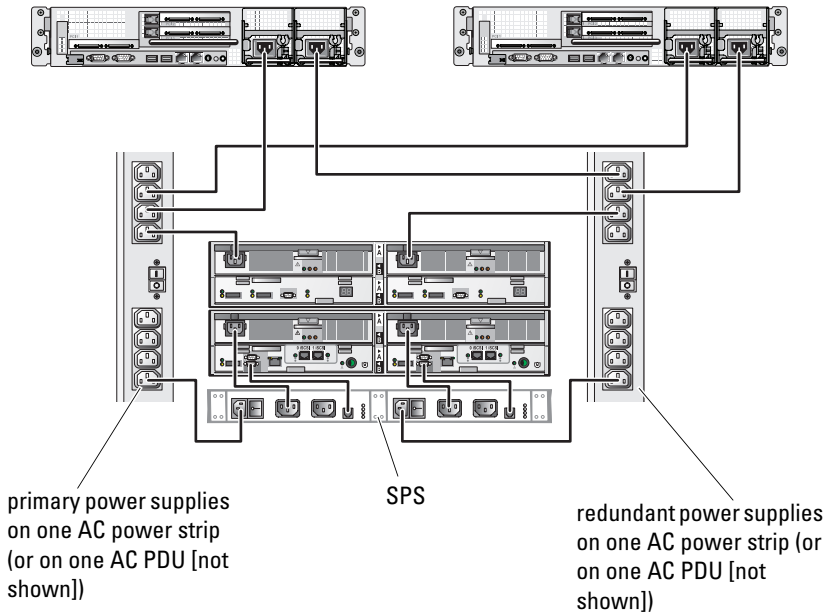
The network adapters in the cluster nodes provide at least two network connections for each node, as described in Table 2-1.

NOTE: To configure Dell blade server modules in a Dell PowerEdge cluster, see the *Using Dell Blade Servers in a Dell PowerEdge High Availability Cluster* document located on the Dell Support website at support.dell.com.

Table 2-1. Network Connections

Network Connection	Description
Public network	All connections to the client LAN. At least one public network must be configured for Mixed mode for private network failover.
Private network	A dedicated connection for sharing cluster health and status information only.

Figure 2-3 shows an example of cabling in which dedicated network adapters in each node are connected to each other (for the private network) and the remaining network adapters are connected to the public network.

Figure 2-3. Example of Network Cabling Connection

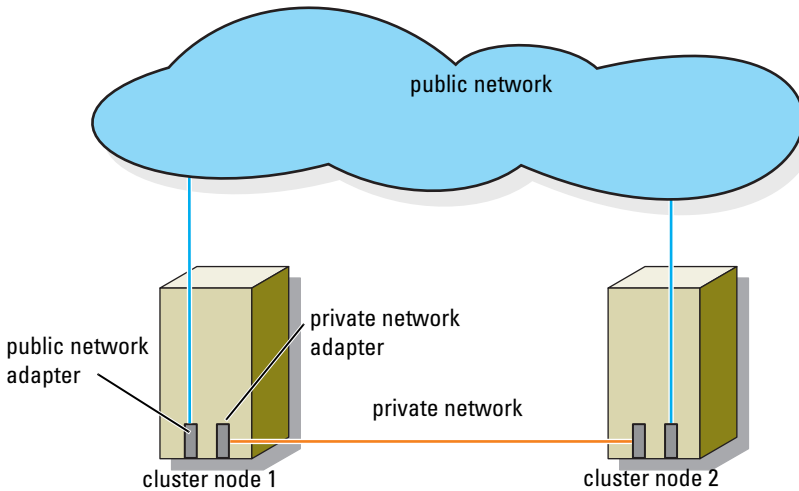

Cabling the Public Network

Any network adapter supported by a system running TCP/IP may be used to connect to the public network segments. You can install additional network adapters to support additional public network segments or to provide redundancy in the event of a faulty primary network adapter or switch port.

Cabling the Private Network

The private network connection to the nodes is provided by a different network adapter in each node. This network is used for intra-cluster communications. Table 2-2 describes three possible private network configurations.

Table 2-2. Private Network Hardware Components and Connections

Method	Hardware Components	Connection
Network switch	Fast Ethernet or Gigabit Ethernet network adapters and switches	Connect <i>standard</i> Ethernet cables from the network adapters in the nodes to a Fast Ethernet or Gigabit Ethernet switch.
Point-to-Point Fast Ethernet (two-node clusters only)	Fast Ethernet network adapters	Connect a <i>crossover</i> Ethernet cable between the Fast Ethernet network adapters in both nodes.
Point-to-Point Gigabit Ethernet (two-node clusters only)	Copper Gigabit Ethernet network adapters	Connect a <i>standard</i> Ethernet cable between the Gigabit Ethernet network adapters in both nodes.



NOTE: Throughout this document, the term *Gigabit Ethernet* refers to either Gigabit Ethernet or 10 Gigabit Ethernet.

Using Dual-Port Network Adapters

You can configure your cluster to use the public network as a failover for private network communications. If dual-port network adapters are used, do not use both ports simultaneously to support both the public and private networks.

NIC Teaming

NIC teaming combines two or more NICs to provide load balancing and fault tolerance. Your cluster supports NIC teaming, but only in a public network; NIC teaming is not supported in a private network and an iSCSI network.

You should use the same brand of NICs in a team, and you cannot mix brands of teaming drivers.

Cabling the Storage Systems

This section provides information for connecting your cluster to a storage system in a direct-attached configuration, or to one or more storage systems in an iSCSI SAN-attached configuration.

Connect the management port on each storage processor to the network where the management station resides on using an Ethernet network cable.

Cabling Storage for Your Direct-Attached Cluster

A direct-attached cluster configuration consists of redundant iSCSI NIC ports cabled directly to a Dell|EMC storage system. Direct-attached configurations are self-contained and do not share any physical resources with other cluster nodes or storage systems outside of the cluster.

Figure 2-4 shows an example of a direct-attached, single cluster configuration with redundant NIC ports installed in each cluster node.

Figure 2-4. Direct-Attached Cluster Configuration

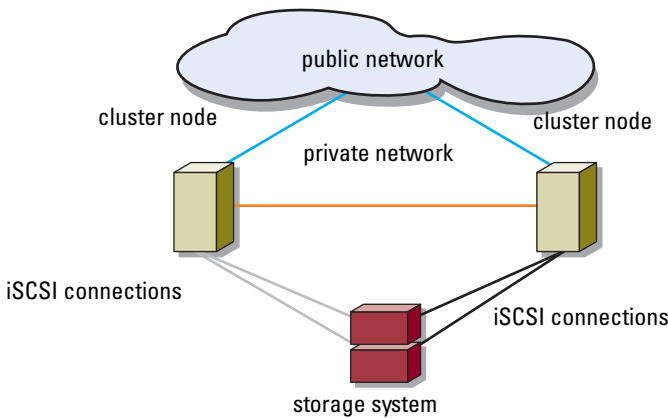

Each cluster node attaches to the storage system using CAT5e or CAT6 LAN cables with RJ45 connectors that attach to Gigabit Ethernet NICs in the cluster nodes and the Gigabit iSCSI storage processor (SP) ports in the Dell|EMC storage system.



NOTE: The connections listed in this section are representative of one proven method of ensuring redundancy in the connections between the cluster nodes and the storage system. Other methods that achieve the same type of redundant connectivity may be acceptable.

Cabling a Two-Node Cluster to an AX4-5i Storage System

Figure 2-5 illustrates methods of cabling a two-node direct-attached cluster to an AX4-5i storage array.

- 1** Connect cluster node 1 to the storage system.
 - a** Install a cable from cluster node 1 iSCSI NIC 0 (or NIC port 0) to SP-A iSCSI port 0.
 - b** Install a cable from cluster node 1 iSCSI NIC 1 (or NIC port 1) to SP-B iSCSI port 0.
- 2** Connect cluster node 2 to the storage system.
 - a** Install a cable from cluster node 2 iSCSI NIC 0 (or NIC port 0) to SP-A iSCSI port 1.
 - b** Install a cable from cluster node 2 iSCSI NIC 1 (or NIC port 1) to SP-B iSCSI port 1.



NOTE: The cables are connected to the storage processor ports in sequential order for illustrative purposes. While the available ports in your storage system may vary, NIC 0 (or NIC port 0) and NIC 1 (or NIC port 1) must be connected to SP-A and SP-B, respectively.

Figure 2-5. Cabling the Cluster Nodes to an AX4-5i Storage System

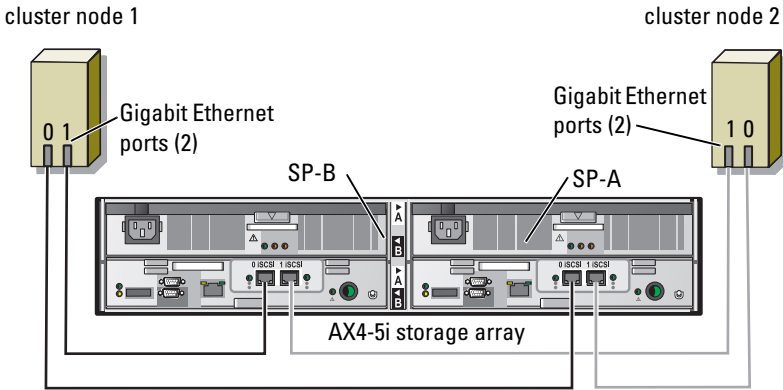

Cabling Storage for Your iSCSI SAN-Attached Cluster

An iSCSI SAN-attached cluster is a cluster configuration where all cluster nodes are attached to a single storage system or to multiple storage systems through a network using a redundant switch fabric.

An iSCSI SAN-attached cluster configuration provides more flexibility, expandability, and performance than a direct-attached configuration.

Figure 2-6 shows an example of a two node iSCSI SAN-attached cluster.

Figure 2-7 shows an example of an eight-node iSCSI SAN-attached cluster.

Similar cabling concepts can be applied to clusters that contain a different number of nodes.



NOTE: The connections listed in this section are representative of one proven method of ensuring redundancy in the connections between the cluster nodes and the storage system. Other methods that achieve the same type of redundant connectivity may be acceptable.

Figure 2-6. Two-Node iSCSI SAN-Attached Cluster

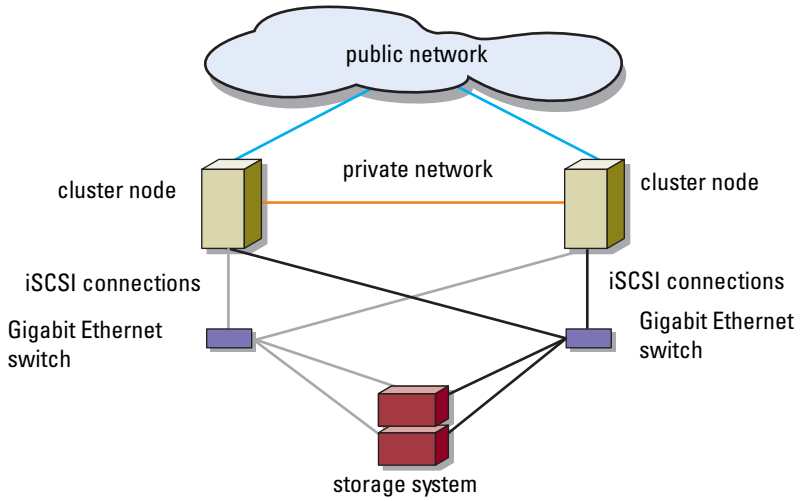
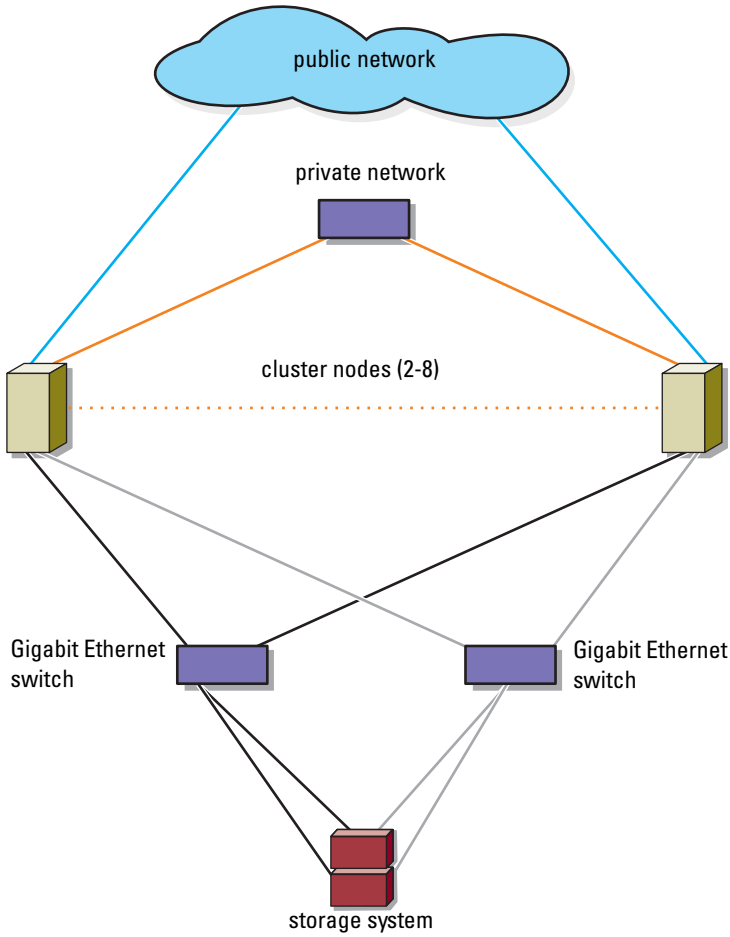

Figure 2-7. Eight-Node iSCSI SAN-Attached Cluster



Cabling One iSCSI SAN-Attached Cluster to a Dell|EMC AX4-5i Storage System

- 1** Connect cluster node 1 to the iSCSI network.
 - a** Connect a network cable from iSCSI NIC 0 (or NIC port 0) to the network switch 0 (sw0).
 - b** Connect a network cable from iSCSI NIC 1 (or NIC port 1) to the network switch 1 (sw1).
- 2** Repeat step 1 for each cluster node.
- 3** Connect the storage system to the iSCSI network.
 - a** Connect a network cable from the network switch 0 (sw0) to SP-A iSCSI port 0.
 - b** Connect a network cable from the network switch 0 (sw0) to SP-B iSCSI port 1.
 - c** Connect a network cable from the network switch 1 (sw1) to SP-A iSCSI port 1.
 - d** Connect a network cable from the network switch 1 (sw1) to SP-B iSCSI port 0.

Figure 2-8. Cabling an iSCSI SAN-Attached Cluster to the Dell|EMC AX4-5i

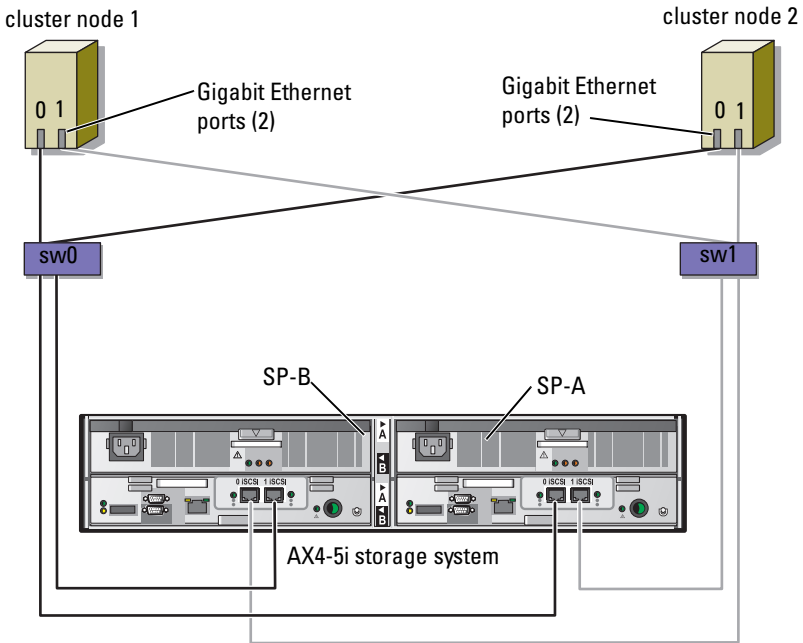

Cabling Multiple iSCSI SAN-Attached Clusters to a Dell|EMC Storage System

To cable multiple clusters to the storage system, connect the cluster nodes to the appropriate iSCSI switches and then connect the iSCSI switches to the appropriate storage processors on the processor enclosure.

For rules and guidelines for iSCSI SAN-attached clusters, see the *Dell Cluster Configuration Support Matrices* located on the Dell High Availability Cluster website at www.dell.com/ha.

Cabling Multiple iSCSI SAN-Attached Clusters to the AX4-5i Storage System



NOTE: The following procedure uses Figure 2-8 as an example for cabling additional clusters.

- 1** In the first cluster, connect cluster node 1 to the iSCSI network.
 - a** Connect a network cable from iSCSI NIC 0 (or NIC port 0) to the network switch 0 (sw0).
 - b** Connect a network cable from iSCSI NIC 1 (or NIC port 1) to the network switch 1 (sw1).
- 2** In the first cluster, repeat step 1 for each node.
- 3** For each additional cluster, repeat step 1 and step 2.
- 4** Connect the storage system to the iSCSI network.
 - a** Connect a network cable from the network switch 0 (sw0) to SP-A iSCSI port 0.
 - b** Connect a network cable from the network switch 0 (sw0) to SP-B iSCSI port 1.
 - c** Connect a network cable from the network switch 1 (sw1) to SP-A iSCSI port 1.
 - d** Connect a network cable from the network switch 1 (sw1) to SP-B iSCSI port 0.

Connecting a PowerEdge Cluster to Multiple Storage Systems

You can increase your cluster storage capacity by attaching multiple storage systems to your cluster using redundant iSCSI networks. PowerEdge cluster systems can support configurations with multiple storage units attached to the clustered nodes. In this scenario, the MSCS software can fail over disk drives in any cluster-attached shared storage array between the cluster nodes.

When attaching multiple storage systems with your cluster, the following rules apply:

- There is a maximum of four storage systems per cluster.
- The shared storage systems and firmware must be identical. Using dissimilar storage systems and firmware for your shared storage is not supported.
- MSCS is limited to 22 drive letters. Because drive letters A through D are reserved for local disks, a maximum of 22 drive letters (E to Z) can be used for your storage system disks.
- Windows Server 2003 and Windows Server 2008 support mount points, allowing greater than 22 drives per cluster. For more information, see *Dell™ Failover Clusters With Microsoft® Windows Server® 2008 Installation and Troubleshooting Guide* or *Dell™ Failover Clusters With Microsoft® Windows Server® 2003 Installation and Troubleshooting Guide* located on the Dell Support website at support.dell.com.

Figure 2-9 provides an example of cabling the cluster nodes to four Dell | EMC storage systems.

Figure 2-9. PowerEdge Cluster Nodes Cabled to Four Storage Systems

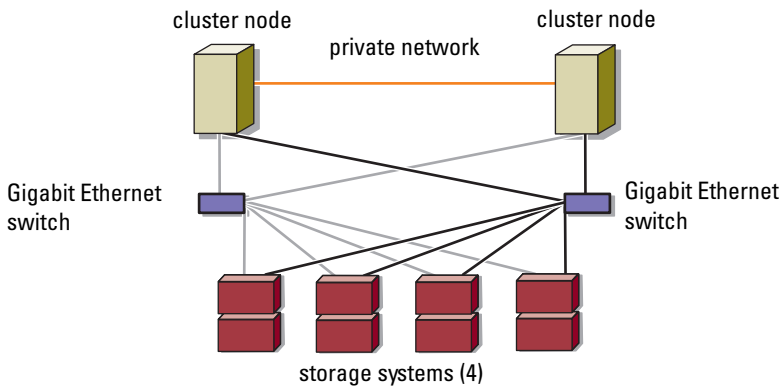

Obtaining More Information

For more information on configuring the cluster components, see the storage and tape backup documentation.

Preparing Your Systems for Clustering

 **CAUTION:** Only trained service technicians are authorized to remove and access any of the components inside the system. For complete information about safety precautions, working inside the computer, and protecting against electrostatic discharge, see the safety information that shipped with your system.

Cluster Configuration Overview

- 1 Ensure that your site can handle the cluster's power requirements. Contact your sales representative for information about your region's power requirements.
- 2 Install the systems, the shared storage array(s), and the interconnect switches (for example, in an equipment rack), and ensure that all the components are turned on.

 **NOTE:** For more information on step 3 to step 7 and step 10 to step 13, see the "Preparing your systems for clustering" section of *Dell Failover Clusters with Microsoft Windows Server 2003 Installation and Troubleshooting Guide* or *Dell Failover Clusters with Microsoft Windows Server 2008 Installation and Troubleshooting Guide* located on the Dell Support website at support.dell.com.

- 3 Deploy the operating system (including any relevant service packs and hotfixes), network adapter drivers, and storage adapter drivers (including Multipath I/O (MPIO) drivers) on each cluster node. Depending on the deployment method that is used, it may be necessary to provide a network connection to successfully complete this step.

 **NOTE:** To help in planning and deployment of your cluster, record the relevant cluster configuration information in the Cluster Data Form located at "Cluster Data Form" on page 49 and the iSCSI configuration information in the iSCSI Configuration Worksheet located at "iSCSI Configuration Worksheet" on page 51.

- 4 Establish the physical network topology and the TCP/IP settings for network adapters on each cluster node to provide access to the cluster public and private networks.
- 5 Configure each cluster node as a member in the same Windows Active Directory Domain.



NOTE: You can configure the cluster nodes as Domain Controllers. For more information, see the "Selecting a Domain Model" section of *Dell Failover Clusters with Microsoft Windows Server 2003 Installation and Troubleshooting Guide* or *Dell Failover Clusters with Microsoft Windows Server 2008 Installation and Troubleshooting Guide* located on the Dell Support website at support.dell.com.

- 6 Establish the physical storage topology and any required storage network settings to provide connectivity between the storage array and the systems that you are configuring as cluster nodes. Configure the storage system(s) as described in your storage system documentation.
- 7 Use storage array management tools to create at least one logical unit number (LUN). The LUN is used as a cluster Quorum disk for Windows Server 2003 Failover cluster and as a Witness disk for Windows Server 2008 Failover cluster. Ensure that this LUN is presented to the systems that you are configuring as cluster nodes.



NOTE: For security reasons, it is recommended that you configure the LUN on a single node as mentioned in step 8 when you are setting up the cluster. Later, you can configure the LUN as mentioned in step 9 so that other nodes in the cluster can access it.

- 8 Select one of the systems and form a new failover cluster by configuring the cluster name, cluster management IP, and quorum resource. For more information, see "Preparing Your Systems for Clustering" on page 27.



NOTE: For Failover Clusters configured with Windows Server 2008, run the **Cluster Validation Wizard** to ensure that your system is ready to form the cluster.

- 9 Join the remaining node(s) to the failover cluster. For more information, see "Preparing Your Systems for Clustering" on page 27.
- 10 Configure roles for cluster networks. Take any network interfaces that are used for iSCSI storage (or for other purposes outside of the cluster) out of the control of the cluster.

- 11 Test the failover capabilities of your new cluster.



NOTE: For Failover Clusters configured with Windows Server 2008, you can also use the **Cluster Validation Wizard**.

- 12 Configure highly-available applications and services on your Failover Cluster. Depending on your configuration, this may also require providing additional LUNs to the cluster or creating new cluster resource groups. Test the failover capabilities of the new resources.
- 13 Configure client systems to access the highly-available applications and services that are hosted on your failover cluster.

Installation Overview

Each cluster node in the Failover Cluster must have the same release, edition, service pack, and processor architecture of the Windows Server operating system installed. For example, all nodes in your cluster may be configured with the Windows Server 2003 R2, Enterprise x64 Edition operating system. If the operating system varies among nodes, it is not possible to configure a failover cluster successfully. It is recommended that you establish server roles prior to configuring a failover cluster, depending on the operating system configured on your cluster.

For a list of Dell PowerEdge systems, iSCSI NICs, recommended list of operating system variants, and specific driver and firmware revisions, see the *Dell Cluster Configuration Support Matrices* located on the Dell High Availability Cluster website at www.dell.com/ha.

For more information on deploying your cluster with Windows Server 2003 operating systems, see the *Dell™ Failover Clusters with Microsoft Windows Server 2003 Installation and Troubleshooting Guide* located on the Dell Support website at support.dell.com. For more information on deploying your cluster with Windows Server 2008 operating systems, see the *Dell Failover Clusters with Microsoft Windows Server 2008 Installation and Troubleshooting Guide* located on the Dell Support website at support.dell.com.

The following sub-sections describe steps that enable you to establish communication between the cluster nodes and your shared Dell|EMC AX4-5i storage array, and to present disks from the storage array to the cluster. The following installation procedures are discussed in the subsequent sections:

- "Installing the iSCSI NICs" on page 30
- "Installing the Microsoft iSCSI Software Initiator" on page 30
- "Modifying the TCP Registry Settings" on page 31]
- "Installing EMC® PowerPath®" on page 31
- "Configuring the Shared Storage System" on page 32
- "Installing and Configuring a Failover Cluster" on page 41

Installing the iSCSI NICs

It is recommended that you install the latest supported version of the driver. If the NIC driver requires any service packs or hotfixes to be installed along with the operating system, install them at this time.

For information about supported NICs and drivers, see the *Dell Cluster Configuration Support Matrices* located on the Dell High Availability Cluster website at www.dell.com/ha.

Installing the Microsoft iSCSI Software Initiator

- 1 Use a web browser and go to the Microsoft Download Center website at www.microsoft.com/downloads.
- 2 Search for *iscsi initiator*.
- 3 Select and download the latest supported initiator software and related documentation for your operating system.



NOTE: For the latest supported Software Initiator version, see the *Dell Cluster Configuration Support Matrices* located on the Dell High Availability Cluster website at www.dell.com/ha.

- 4 Double-click the executable file. The installation wizard launches. In the **Welcome** screen, click **Next**.
- 5 In the following screens select the **Initiator Service**, **Software Initiator**, and **Microsoft MPIO Multipathing Support for iSCSI** options. Click **Next** to continue with the installation.

- 6 Read and accept the license agreement and click **Next** to install the software.
- 7 At the completion screen, click **Finish** to complete the installation.
- 8 Select the **Do not restart now** option to reboot the system after modifying the TCP/IP registry settings in the section "Configuring the Shared Storage System" on page 32.

Modifying the TCP Registry Settings

To modify the TCP Registry:

- 1 Determine the IP addresses or the DHCP IP addresses that are used for iSCSI traffic.
- 2 Start the Registry Editor.
 - a Select **Start**→ **Run**.
 - b Type `Regedit` and click **OK**.
- 3 Locate and click the registry subkey at:
HKEY_LOCAL_MACHINE→ SYSTEM→ CurrentControlSet→ Services→ Tcpip→ Parameters→ Interfaces
- 4 Click each interface GUID associated with the iSCSI networks, and perform the following steps:
 - a Select **Edit**→ **New**→ **DWORD** value.
 - b Name the new value `TcpAckFrequency`.
 - c Assign a value of 1.
- 5 Exit the Registry Editor.

Installing EMC® PowerPath®

EMC PowerPath detects a failed storage path and automatically re-routes I/O through an alternate path. PowerPath also provides load balancing of data from the cluster node to the storage system. To install PowerPath:

- 1 Insert the PowerPath installation media in the CD/DVD drive.
- 2 On the **Getting Started** screen, go to the **Installation** section, and click the appropriate link for the operating system that is running on the node.
- 3 Select **Run this program from its current location** and click **OK**.

- 4 In the **Choose Language Setup** screen, select the required language, and click **OK**.
- 5 In the **Welcome** window of the setup wizard, click **Next**.
- 6 In the **CLARiiON AX-series** window, select **PowerPath** and click **Next**. Follow the on-the-screen instructions to complete the installation.
- 7 Click **Yes** to reboot the system.

Configuring the Shared Storage System

To install and configure the Dell|EMC storage system in your cluster:

- 1 Install and use Navisphere Storage System Initialization Utility from a node or management station to initialize your AX4-5i storage system. During initialization, configure the network settings and create a user account to manage the AX4-5i storage system from the network.
- 2 If applicable, install the expansion pack using Navisphere Express.
- 3 Install the Navisphere Server Utility on each cluster node.
- 4 Configure the iSCSI Initiator on each cluster node.
- 5 Assign the virtual disks to the cluster nodes.

Installing the Navisphere Storage System Initialization Utility

The Navisphere Storage System Initialization Utility provides a user interface to initialize your AX4-5i storage system. Using the utility, you can configure the IP address, subnet mask, default gateway address for the storage system's SPs, and assign user names and passwords for storage system access.

To install the software from the support media that is shipped with the storage system:

- 1 Insert the support media in the CD/DVD drive of the cluster node or the management station.
- 2 If prompted, select the language.
- 3 Click **Install Products**.
- 4 From the **Install Products** menu, click **Navisphere Storage System Initialization Utility**.

- 5 Follow the on-screen instructions to complete the installation.
- 6 To initialize the storage system:
 - a From the cluster node or management station launch the Navisphere Storage System Initialization Utility that you installed. Go to **Start**→**Programs**→**EMC**→**Navisphere**→**Navisphere Storage System Initialization**.
 - b Read the license agreement, click **I accept**, and then click **Next**.
 - c From the **Uninitialized Systems** list, select the storage system to be initialized, and click **Next**.
 - d Follow the on-screen instructions to complete the initialization.

Installing the Expansion Pack Using Navisphere Express

Each storage system in the cluster is centrally managed by one host system (also called a management station) running EMC® Navisphere™ Express—a centralized storage management application used to configure Dell | EMC storage systems.

If you have an expansion pack option for the storage system and it has not been installed, install it at this time:

- 1 From the management host, open a web browser.
- 2 Enter the IP address of an SP in the storage system.
- 3 Log in to Navisphere Express with the username and password that you specified during the storage system initialization.
- 4 Go to **System**→**Navisphere Express** navigation pane and click **Software**.
- 5 In the **System Software** window, click **Upgrade Software**.
- 6 Insert the expansion pack media into the CD/DVD drive on the host from which you are running Navisphere Express.
- 7 Browse the media for the expansion tier enabler software file (.ena file), and click **Upgrade**.

You can use Navisphere Express to perform tasks such as creating disk pools, binding the virtual disks, and downloading the firmware. Additionally, you can use Snapshot Management to capture point-in-time images of a virtual disk for backups or testing without affecting the contents of the source virtual disk. You can also use the SAN Copy feature in Navisphere Express to move data from the virtual disks on one storage system to the virtual disks on another storage system without using the host CPU cycles.

Configuring the Navisphere Server Utility

The Navisphere Server Utility registers the cluster node NICs with the storage systems, allowing the nodes to access the cluster storage data. The tool is also used for cluster node maintenance procedures, such as:

- Updating the cluster node host name and/or IP address on the storage array
- Updating the file system information
- Adding, removing, or replacing a NIC
- Starting and stopping a snapshot

To install Navisphere Server Utility:

- 1** Log in to the Windows Server operating system as an administrator.
- 2** Insert the system support media into the cluster node.
- 3** If prompted, select the language.
- 4** From the **Main Menu**, click **Install Products on Server**.
- 5** From the **Install Products** menu, click **Navisphere Server Utility**.
- 6** Follow the on-screen instructions retaining all the default values to complete the installation.

Configuring the iSCSI Initiator

Configuring the iSCSI Initiator using iSNS

iSNS includes an iSNS server component and iSNS client component. The iSNS server must reside within the IP storage network on a host or in the switch firmware. An iSNS client resides on both the iSCSI storage system and any iSCSI systems connected to the storage system. iSNS provides the following services:

- Name registration and discovery services – Targets and initiators register their attributes and addresses. After the targets and initiators register, they can obtain information about other initiators or targets.



NOTE: The iSCSI Initiator (usually a host server) converts blocks of SCSI commands and data into a format suitable for an IP network. The iSCSI Initiator is configured with a unique iSCSI name or Internet Qualified Name (IQN) in a PowerEdge system, allowing an administrator to identify and manage. For iSCSI access, the iSCSI Initiator assigns the same iSCSI name to all NICs in the PowerEdge system so they appear as one single initiator. However, each NIC is still identified by a unique IP address. The PowerEdge SE600Wi cluster solution supports NICs with Microsoft Software Initiator and does not support iSCSI HBAs. An iSCSI target (usually a storage device) receives iSCSI commands from the initiator. Each iSCSI target is identified by a unique IQN and each port on the storage array controller is identified by an IP address.

- State-change notification service – The iSNS server notifies relevant iSNS clients of network events that could affect their operational states such as storage resources going offline, domain membership change, and link failure in a network. These notifications let iSNS clients quickly adapt to changes in topology.

- Discovery domains and login control service – Resources in a typical storage network are divided into manageable groups called discovery domains. Discovery domains help scale the storage network by reducing the number of unnecessary logins; each initiator only logs in to a subset of targets which are within the domain. Each target can use Login Control to subordinate its access control policy to the iSNS server. Only initiators matching the required identification and authentication are allowed access by the target during session establishment.
- Open mapping of Fibre Channel and iSCSI devices – The iSNS database can store information about Fibre Channel and iSCSI devices and mappings between the two in a multi-protocol environment. The mapped information is then available to any authorized iSNS client.

When you start the storage system, the iSNS client on the storage system gathers all the storage-system iSCSI port information and stores it locally on the storage system. When you add a cluster node to the storage system iSNS configuration, Navisphere Express establishes a connection from the storage system to the iSNS server, and then registers the information stored on the storage system with the iSNS server.

For information about setting the iSNS service in your iSCSI storage network, see your Microsoft and EMC documentation.



NOTE: iSNS is supported only on systems running a Windows operating system in an iSCSI network configuration.

To configure iSNS client, login to Navisphere Express. For each iSNS server to which you want the storage system to connect:

- 1 In the **Manage iSCSI** window, click **iSNS**.
- 2 In the **iSNS Servers** window, click **Add**.
- 3 In the **Add iSNS Servers** dialog box, enter the IP address of the cluster node you are adding.
- 4 Click **Apply** to notify the SP iSCSI port information to the cluster node.
- 5 In the **iSNS Servers** dialog box, select the cluster node that you want to configure as the primary server and click **Set Primary**.

To connect to the storage system:

- 1** On the cluster node, open the Navisphere Server Utility.
- 2** Select **Configure iSCSI Connections on this cluster node** and click **Next**.
- 3** Select **Configure iSCSI Connections** and click **Next**.
- 4** In the **iSCSI Targets and Connections** window, select **Discover iSCSI targets using this iSNS server** to send a request to the iSNS server for all connected iSCSI storage-system targets, and click **Next**.
- 5** For each target you want to log into:
 - a** In the **iSCSI Targets** window, select the IP address of the Inactive target.
 - b** In the **Login Options** section, select **Also login to peer iSCSI target for High Availability** (recommended) if the peer iSCSI target is listed.
 - c** If you selected the **Also login to peer iSCSI target for High Availability** option (recommended) in step b, leave the **Server Network Adapter IP** set to **Default**. This allows the iSCSI initiator to automatically fail over to an available NIC in the event of a failure.
 - d** Click **Logon** to connect to the selected target.
 - e** If the CHAP authentication is enabled on the target, a CHAP login dialog box is displayed.

Enter the CHAP security information. If you also use mutual CHAP for the software Initiator to authenticate the target, select the **Mutual CHAP** option and click **OK**.
- 6** Click **Next**. If the **Network Interfaces (NICs)** window is displayed, go to step 7. If the **Server Registration** window is displayed, go to step 8.
- 7** In the **Network Interfaces (NICs)** window:
 - a** Deselect any NICs that are used for general network traffic and click **Apply**. A confirmation dialog is displayed stating that the network settings for your NICs have been updated and you must restart your system to apply them.
 - b** Click **OK** and then click **Next**.
- 8** In the **Server Registration** window, click **Next** to send the updated information to the storage system.
- 9** Click **Finish** to close the wizard.

Configuring the iSCSI Initiator without iSNS

On the cluster node:

- 1** Open the Navisphere Server Utility.
- 2** Select **Configure iSCSI Connections on this cluster node** and click **Next**.
- 3** Select **Configure iSCSI Connections** and click **Next**.
- 4** In the **iSCSI Targets and Connections** window, select one of the following options to discover the iSCSI target ports on the connected storage systems:
 - **Discover iSCSI targets on this subnet** - Scans the current subnet for all connected iSCSI storage-system targets. The utility scans the subnet in the range from 1 to 255.

If CHAP authentication is enabled on all target ports on a storage system, you cannot discover the iSCSI target ports using a subnet scan. You must discover the targets using the target portal.
 - **Discover iSCSI targets for this target portal** - Discovers targets known to the specified iSCSI SP data port.
- 5** Click **Next**.
- 6** For each target you want to log in to:
 - a** In the **iSCSI Targets** window, select the IP address of the Inactive target.
 - b** In the **Login Options** section, select **Also login to peer iSCSI target for High Availability** (recommended) if the peer iSCSI target is listed.
 - c** If you selected **Also login to peer iSCSI target for High Availability** (recommended) in step b, leave the **Server Network Adapter IP** set to **Default** to allow the iSCSI initiator to automatically fail over to an available NIC in the event of a failure.
 - d** Click **Logon** to connect to the selected target.
 - e** If the CHAP authentication is enabled on the target, a CHAP login dialog box is displayed.

Enter the CHAP security information. If you also use mutual CHAP for the software Initiator to authenticate the target, select the **Mutual CHAP** option and click **OK**.

- 7 Click **Next**. If the **Network Interfaces (NICs)** window is displayed, go to step 8. If the **Server Registration** window is displayed, go to step 9.
- 8 In the **Network Interfaces (NICs)** window:
 - a Deselect any NICs that are used for general network traffic and click **Apply**.
 - b Click **OK** and then click **Next**.
- 9 In the **Server Registration** window, click **Next** to send the updated information to the storage system.
- 10 Click **Finish** to close the wizard.

Assigning the Virtual Disks to Cluster Nodes



NOTE: For best practices, configure at least one virtual disk for each application. If multiple NTFS partitions are created on a single LUN or virtual disk, these partitions are not able to failover individually from node-to-node.

To perform data I/O to the virtual disks, assign the virtual disks to a cluster node by performing the following steps:

- 1 Open a Web browser.
- 2 In the **Address** field, type the storage system IP address. The Navisphere Express console appears.
- 3 Login with the user name and password that was created during the storage initialization.
- 4 In the **Manage** menu:
 - a Click **Disk Pools**. Create one or more disk pools.
 - b Click **Virtual Disks**. Create one or more Virtual Disks for each disk pool.
 - c Click **Virtual Disks**, select the virtual disks that you want to assign to the cluster node, and then click **Assign Server**.
- 5 In **Virtual Disk - Assign Server** screen, select the cluster nodes that you want to assign to the virtual disk and click **Apply**.
- 6 Repeat steps 4 and 5 for each virtual disk.
- 7 Close the **Navisphere Express** window.
- 8 Verify that the PowerPath on the cluster nodes can access all paths to the virtual disks.

Advanced Storage Features (Optional)

Your Dell | EMC AX4-5i storage array may be configured to provide advanced features that can be used with your cluster. These features include Snapshot Management, SANCopy, Navisphere Manager, and MirrorView. The following sections describe these features.

Snapshot Management

Snapshot Management captures images of a virtual disk and retains the image independently of subsequent changes to the files. The images can be used to share virtual disks with another system without affecting the contents of the source virtual disk. Snapshot Management creates copies of either virtual disks or snapshots. Snapshots are virtual copies that create an image of the source virtual disk at the time the snapshot was created. This snapshot is retained independently of subsequent changes to the source virtual disk. You can use snapshots to facilitate backups or to allow multiple hosts to access data without affecting the contents of the source virtual disk.



NOTICE: To avoid data corruption, do not access a snapshot from the same node from where you are accessing the source.

SAN Copy

SAN Copy allows you to move data between storage systems without using host processor cycles or LAN bandwidth. It can be used in conjunction with SnapView or MirrorView and is managed from within Navisphere Manager.

Navisphere Manager

Optionally, you can also upgrade Navisphere Express to EMC Navisphere[®] Manager—a centralized storage management application used to configure Dell | EMC storage systems.

EMC Navisphere Manager adds the support for EMC MirrorView[™]—an optional software that enables synchronous or asynchronous mirroring between two storage systems.

MirrorView

MirrorView automatically duplicates primary storage system data from a cluster or stand-alone system to a secondary storage system. It can be used in conjunction with SnapView and is managed from within Navisphere Manager.

Installing and Configuring a Failover Cluster

You can configure the operating system services on your Failover Cluster, after you have established the private and public networks and have assigned the shared disks from the storage array to the cluster nodes. The procedures for configuring the failover cluster are different depending on the Windows Server operating system you use.

For more information on deploying your cluster with Windows Server 2003 operating systems, see the *Dell™ Failover Clusters with Microsoft Windows Server 2003 Installation and Troubleshooting Guide* located on the Dell Support website at support.dell.com. For more information on deploying your cluster with Windows Server 2008 operating systems, see the *Dell Failover Clusters with Microsoft Windows Server 2008 Installation and Troubleshooting Guide* located on the Dell Support website at support.dell.com.

Troubleshooting

This appendix provides troubleshooting information for your cluster configuration.

Table A-1 describes general cluster problems you may encounter and the probable causes and solutions for each problem.

Table A-1. General Cluster Troubleshooting

Problem	Probable Cause	Corrective Action
The nodes cannot access the storage system, or the cluster software is not functioning with the storage system.	The storage system is not cabled properly to the nodes or the cabling between the storage components is incorrect.	Ensure that the cables are connected properly from the node to the storage system. For more information, see "Cabling Your Cluster for Public and Private Networks" on page 15.
	One of the cables is faulty.	Replace the faulty cable.
	LUNs are not assigned to the hosts.	Verify that all LUNs are assigned to the hosts.
One of the nodes takes a long time to join the cluster. OR One of the nodes fail to join the cluster.	The node-to-node network has failed due to a cabling or hardware failure.	Check the network cabling. Ensure that the node-to-node interconnection and the public network are connected to the correct NICs.
	Long delays in node-to-node communications may be normal.	Verify that the nodes can communicate with each other by running the ping command from each node to the other node. Try both the host name and IP address when using the ping command.

Table A-1. General Cluster Troubleshooting (continued)

Problem	Probable Cause	Corrective Action
	One or more nodes may have the Internet Connection Firewall enabled, blocking Remote Procedure Call (RPC) communications between the nodes.	Configure the Internet Connection Firewall to allow communications that are required by the Microsoft® Cluster Service (MSCS) and the clustered applications or services. For more information, see Microsoft Knowledge Base article KB883398 at the Microsoft Support website at support.microsoft.com .
Attempts to connect to a cluster using Cluster Administrator fail.	The Cluster Service has not been started. A cluster has not been formed on the system. The system has just been booted and services are still starting.	Verify that the Cluster Service is running and that a cluster has been formed. Use the Event Viewer and look for the following events logged by the Cluster Service: Microsoft Cluster Service successfully formed a cluster on this node. OR Microsoft Cluster Service successfully joined the cluster. If these events do not appear in Event Viewer, see the Microsoft Cluster Service Administrator's Guide for instructions on setting up the cluster on your system and starting the Cluster Service.

Table A-1. General Cluster Troubleshooting (continued)

Problem	Probable Cause	Corrective Action
	The cluster network name is not responding on the network because the Internet Connection Firewall is enabled on one or more nodes.	Configure the Internet Connection Firewall to allow communications that are required by MSCS and the clustered applications or services. For more information, see Microsoft Knowledge Base article KB883398 at the Microsoft Support website at support.microsoft.com .
You are prompted to configure one network instead of two during MSCS installation.	The TCP/IP configuration is incorrect.	The node-to-node network and public network must be assigned static IP addresses on different subnets.
	The private (point-to-point) network is disconnected.	Ensure that all systems are powered on so that the NICs in the private network are available.
Using Microsoft Windows NT® 4.0 to remotely administer a Windows Server 2003 cluster generates error messages.	Normal. Some resources in Windows Server 2003 are not supported in Windows NT 4.0.	Dell strongly recommends that you use Windows XP Professional or Windows Server 2003 for remote administration of a cluster running Windows Server 2003.

Table A-1. General Cluster Troubleshooting (continued)

Problem	Probable Cause	Corrective Action
Unable to add a node to the cluster.	The new node cannot access the shared disks.	Ensure that the new cluster node can enumerate the cluster disks using Windows Disk Administration. If the disks do not appear in Disk Administration, check the following: <ul style="list-style-type: none">• Check all cable connections• Check the LUN assignments• In the Advanced option, select Minimum value
	The shared disks are enumerated by the operating system differently on the cluster nodes.	
The disks on the shared cluster storage appear unreadable or uninitialized in Windows Disk Administration	This situation is normal if you stopped the Cluster Service. If you are running Windows Server 2003, this situation is normal if the cluster node does not own the cluster disk.	No action required.

Table A-1. General Cluster Troubleshooting (continued)

Problem	Probable Cause	Corrective Action
Cluster Services does not operate correctly on a cluster running Windows Server 2003 and the Internet Firewall enabled.	The Windows Internet Connection Firewall is enabled, which may conflict with Cluster Services.	<p>Perform the following steps:</p> <ol style="list-style-type: none">1 On the Windows desktop, right-click My Computer and click Manage.2 In the Computer Management window, double-click Services.3 In the Services window, double-click Cluster Services.4 In the Cluster Services window, click the Recovery tab.5 Click the First Failure drop-down arrow and select Restart the Service.6 Click the Second Failure drop-down arrow and select Restart the service.7 Click OK. <p>For information on how to configure your cluster with the Windows Internet Connection Firewall enabled, see Microsoft Base (KB) articles 258469 and 883398 at the Microsoft Support website at support.microsoft.com and the Microsoft Windows Server 2003 Technet website at www.microsoft.com/technet.</p>

Table A-1. General Cluster Troubleshooting (continued)

Problem	Probable Cause	Corrective Action
Public network clients cannot access the applications or services that are provided by the cluster.	One or more nodes may have the Internet Connection Firewall enabled, blocking RPC communications between the nodes.	Configure the Internet Connection Firewall to allow communications that are required by the MSCS and the clustered applications or services. For more information, see Microsoft Knowledge Base article KB883398 at the Microsoft Support website at support.microsoft.com .

Cluster Data Form

You can attach the following form in a convenient location near each cluster node or rack to record information about the cluster. Use the form when you call for technical support.

Table B-1. Cluster Configuration Information

Cluster Information	Cluster Solution
Cluster name and IP address	
Server type	
Installer	
Date installed	
Applications	
Location	
Notes	

Table B-2. Cluster Node Configuration Information

Node Name	Service Tag Number	Public IP Address	Private IP Address

Table B-3. Additional Network Information

Additional Networks

Table B-4. Storage Array Configuration Information

Array	Array Service Tag	IP Address	Number of Attached DAEs	Virtual Disks
1				
2				
3				
4				

iSCSI Configuration Worksheet

If you need additional space for more than one host server, use an additional sheet.

A	Static IP address (host server)	Subnet	Default Gateway
Server 1, iSCSI NIC port 0	__ . __ . __ . __	__ . __ . __ . __	__ . __ . __ . __
Server 1, iSCSI NIC port 1	__ . __ . __ . __	__ . __ . __ . __	__ . __ . __ . __
Server 2, iSCSI NIC port 0	__ . __ . __ . __	__ . __ . __ . __	__ . __ . __ . __
Server 2, iSCSI NIC port 1	__ . __ . __ . __	__ . __ . __ . __	__ . __ . __ . __
Server 3, iSCSI NIC port 0	__ . __ . __ . __	__ . __ . __ . __	__ . __ . __ . __
Server 3, iSCSI NIC port 1	__ . __ . __ . __	__ . __ . __ . __	__ . __ . __ . __

**Mutual CHAP
Secret**

B	Static IP address (storage array)	Subnet	Default Gateway
SP-A, iSCSI port 0	__ . __ . __ . __	__ . __ . __ . __	__ . __ . __ . __
SP-A, iSCSI port 1	__ . __ . __ . __	__ . __ . __ . __	__ . __ . __ . __
SP-B, iSCSI port 0	__ . __ . __ . __	__ . __ . __ . __	__ . __ . __ . __
SP-B, iSCSI port 1	__ . __ . __ . __	__ . __ . __ . __	__ . __ . __ . __

**Target CHAP
Secret**

Index

C

- cable configurations
 - cluster interconnect, 17
 - for client networks, 16
 - for mouse, keyboard, and monitor, 13
 - for power supplies, 13
- cluster
 - optional configurations, 9
- cluster configurations
 - connecting to multiple shared storage systems, 25
 - connecting to one shared storage system, 9
 - direct-attached, 9, 18
 - iSCSI SAN-attached, 10
- cluster storage
 - requirements, 8
- clustering
 - overview, 5

D

- Dell | EMC AX4-5i
 - Cabling a two-node cluster, 19
- Dell | EMC AX4-5i
 - Cabling a two-node cluster, 19
 - cabling the cluster nodes in an iSCSI SAN-attached environment, 23
 - cabling to one iSCSI SAN-attached cluster, 23
 - configuring, 32
 - installing, 32
- direct-attached cluster
 - about, 18

I

- iSCSI
 - configuring the iSCSI NIC, 30
- iSCSI SAN-attached cluster
 - about, 20
 - configurations, 9

K

keyboard
cabling, 13

M

monitor
cabling, 13

mouse
cabling, 13

MSCS
installing and configuring, 41

N

network adapters
cabling the private
network, 16-17
cabling the public network, 16

O

operating system
Windows Server 2003, Enterprise
Edition
installing, 29

P

power supplies
cabling, 13
private network
cabling, 15, 17
hardware components, 17
hardware components and
connections, 17
public network
cabling, 15

T

troubleshooting
connecting to a cluster, 44
shared storage subsystem, 43

W

warranty, 11